

Astro-Pop Warmer

Part No. 40269EX
Revised February 1997

Instruction Manual
Models #2004EX





 **GOLD MEDAL®**

FUNFOOD EQUIPMENT & SUPPLIES

Cincinnati, OH 45241-4807 USA

SAFETY PRECAUTIONS

	⚠ CAUTION
	<p>This equipment is designed and sold for commercial use only. This equipment is not to be used by the consumer in home use. Do not allow direct contact of this equipment by the public when used in food service locations. Only personnel trained and experienced in the equipment operation may operate this equipment. Carefully read all installation instructions before operating the equipment.</p>

	⚠ WARNING
	<p>Always wear safety glasses when servicing this equipment.</p>

	⚠ WARNING
	<p>To avoid serious burns, do NOT touch the kettle while it is hot.</p>

	⚠ WARNING
	<p>Any alterations to this equipment will void the warranty and may cause a dangerous situation. NEVER make alterations to the equipment. Make sure all machine switches are in the OFF position before plugging the equipment into a receptacle.</p>

	⚠ DANGER
	<p>Machine must be properly grounded to prevent electrical shock to personnel. Do NOT immerse the kettle, warmer, or any other part of this equipment in water. Always unplug the equipment before cleaning or servicing.</p>

NOTE

The information, specifications and illustrations contained in this manual represent the latest data available at time of publication. Right is reserved to make changes as required at the discretion of Gold Medal Products Company without notice.

INTRODUCTION

Your new #2004EX Astro-Pop Warmer is shipped completely assembled, ready to operate. After removing the corrugated carton from the machine, check thoroughly for any damage which may have occurred in transit. Claims should be filed immediately with the transportation company.

Remove all cardboard packing and tape from the machine. Wipe all exposed surfaces with a damp cloth to remove fingerprints, smears, etc. which may have occurred during unpacking and handling.

ELECTRICAL REQUIREMENTS

Standard voltage for the Astro-Pop Warmer is 230V, 50 cycle, single phase, A.C. current. The unit should be placed on its own 20 Amp (4 wire) electrical circuit. The switches to control the heater and lights are located at the top on the inside of the cabinet.

CARE AND CLEANING

The aluminum frame of the Warmer is easy to keep clean. Usually a damp cloth will remove all dirt and grease spots. NEVER USE ABRASIVES on the aluminum framework. The glass should always be clean and sparkling. Remember the inside of the glass must be cleaned too. The vertical air ducts, mounted on the inside of the cabinet, disassemble without tools for easy cleaning. Periodically, empty out all the popcorn and remove the shelves and clean the inside of the machine. A damp cloth will usually pick up all the scraps of popcorn that has been spilled. Empty the old maid drawers and wipe clean. Remove the bottom cabinet pans and clean out any stray debris.

MAINTENANCE INSTRUCTIONS

	⚠ CAUTION
	<p>THE FOLLOWING SECTIONS OF THIS MANUAL ARE INTENDED ONLY FOR QUALIFIED SERVICE PERSONNEL WHO ARE FAMILIAR WITH ELECTRICAL EQUIPMENT. THESE ARE NOT INTENDED FOR THE OPERATOR.</p>

	⚠ WARNING
	<p>Adequate eye protection must be used when servicing this equipment to prevent the possibility of injury.</p>

	⚠ DANGER
	<p>Do NOT immerse the kettle, warmer, or any other part of this equipment in water. Unplug your machine before servicing.</p>

ORDERING SPARE PARTS

1. Identify the desired part by checking it against the photos, illustrations, and/or the parts list.
2. When ordering, please include part number, part name, and quantity desired.
3. Please include your model name and machine serial number (located on the machine nameplate) with your order.
4. Address parts orders to:

Parts Department
 Gold Medal Products Co.
 10700 Medallion Drive
 Cincinnati, Ohio 45241-4807

or, place orders at:
 (513) 769-7676
 Fax: (513) 769-8500
 E-mail: goldme19@eos.net

NOTE: We do not ship glass. Obtain replacement glass from your local glass shop or hardware store. Always purchase double strength type glass. Sizes are:

FRONT GLASS	32 ³ / ₁₆ " x 31 ¹ / ₁₆ " x ¹ / ₈ " [817,6mm x 789mm x 3mm]
SIDE GLASS	32 ³ / ₁₆ " x 23 ¹ / ₁₆ " x ¹ / ₈ " [817,6mm x 585,8mm x 3mm]

CABINET ASSEMBLY

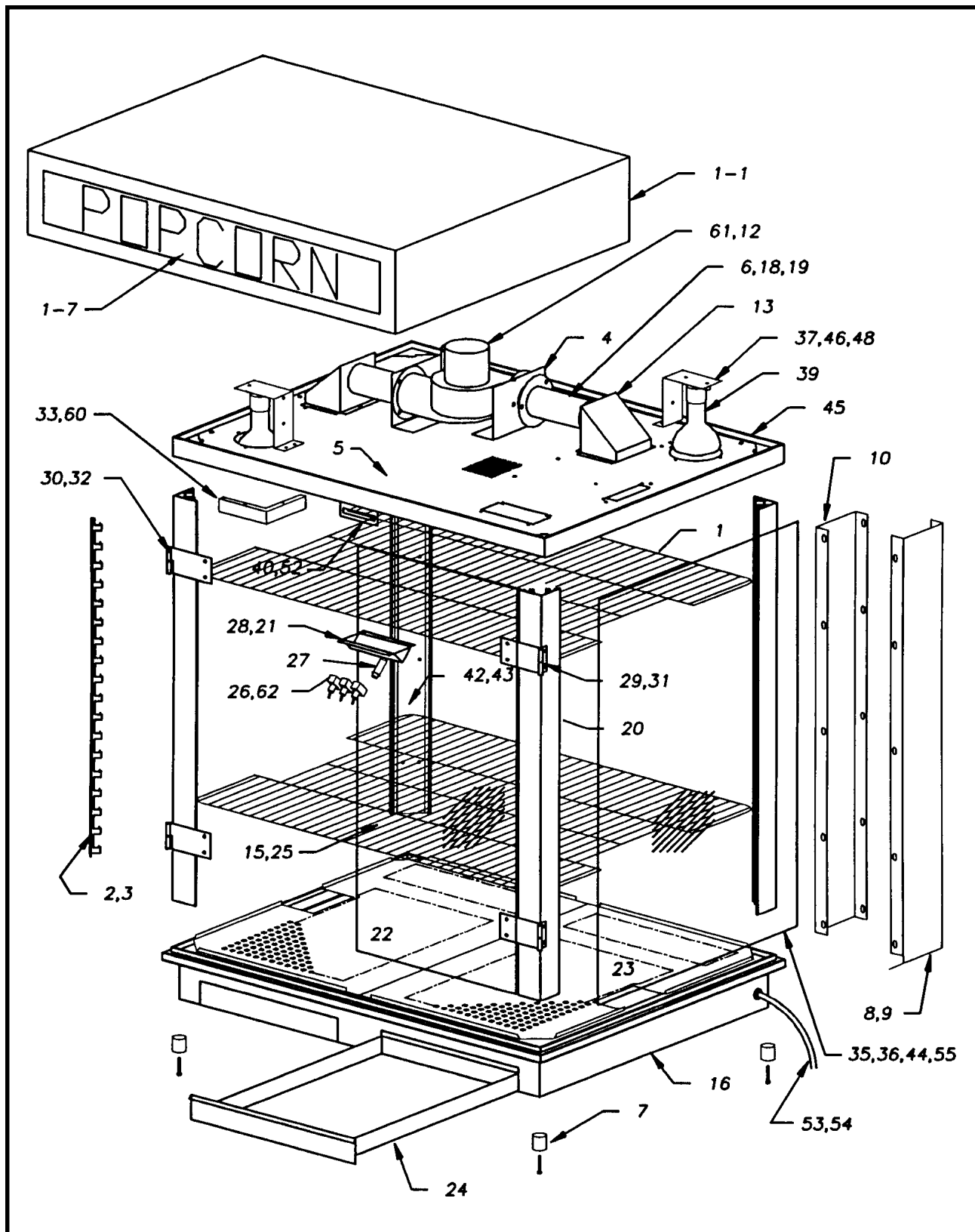

PARTS LIST - CABINET ASSEMBLY

Item No.	Part No.	Description
1	40130	Shelf, Adjustable
2	40143	Shelf Support
3	40142	Shelf Support
4	40145	Blower Bracket
5	40148	Motor Mount Plate
6	40280	Nozzle Heater
7	41282	Rubber Foot
8	40292	Duct Panel
9	40177	Duct Bracket
10	40293	Duct Cover
11	76097	Label, "Unplug to Clean"
12	40184	Intake Cover
13	40185	Exhaust Box
14	n/a	
15	40352	Door
16	40193	Bottom Frame Assembly
17	41870	Corner Post, Front
18	40255	Thermostat
19	40270	Thermostat Mount
20	40192	Corner Post
21	40186	Switch Label
22	40297	Corn Pan, L.H.
23	40296	Corn Pan, R.H.
24	40276	Old Maid Pan
25	41013	Knob, Door
26	n/a	Single Pole Switch
27	41032	Pilot Light
28	41106	Switch Box
29	41349	Male Hinge, Right
30	41350	Male Hinge, Left
31	41351	Female Hinge, Right
32	41352	Female Hinge, Left
33	41452	Warning, 75W Max
34	41456	Strain Relief
35	41635PMO	Glass, Front
36	41636PMO	Glass, Side
37	41643	Light Mount Bracket
38	n/a	
39	49033	Floodlight, 75W
40	41703	Magnet Catch Bracket
41	41712	Molded Receptacle
42	41765	Glass Retainer, Front
43	41766	Glass Retainer, Rear
44	41858	Rigid Channel, 32"
45	41946	Top Frame Assembly

PARTS LIST - CABINET ASSEMBLY (continued)

Item No.	Part No.	Description
46	41956	Light Shield
47	n/a	
48	47047	Lamp Holder
49	n/a	
50	n/a	
51	47282	Bushing, Snap #UB-65
52	47561	Magnetic Catch
53	42366	Lead-In Cord
54	47604	Strain Relief, #SR8P-2
55	47695	Rigid Channel, 23"
56	47701	Acorn Nut, #6-32
57	47702	Acorn Nut, #8-32
58	47771	Screw, #8-32 x 3/8" Hex
59	47772	Screw, #6-32 x 3/8" Flat
60	47799	Light Shield Angle
61	40281	Blower, 50/60 Hz
62	74087	Double Pole Switch
63	74131	Ring Terminal, #10
64	74146	Hex Nut, #8-32
65	74149	Hex Nut, #8-32
66	74150	Washer, #8 Internal Tooth
67	not shown	Magnet Strike
68	not shown	Dome Spacer

PARTS NOT SHOWN – S/S DOME

Item No.	Part No.	Description
1-1	40283	Complete Dome Assembly
1-2	41505	Main Wrapper
1-3	41020	Light Tube Holder
1-4	41021	Holder with Starter
1-5	41503	Support Angle
1-6	41504	Lamp Reflector
1-7	41506	Popcorn Sign
1-8	41507	Fluorescent Tube
1-9	41508	Fluorescent Starter
1-10	41510	Light Ballast
1-11	47726	Molded Plug
1-12	40197	Dome Cover

WARRANTY

WE WARRANT to the original purchaser the Gold Medal equipment sold by us to be free from defects in material or workmanship under normal use and service. Our obligation under this warranty shall be limited to the repair or replacement of any defective part for a period of six (6) months from the date of sale to the Original Purchaser with regard to labor and two (2) years with regard to parts and does not cover damage to the equipment caused by accident, alteration, improper use, voltage, abuse, or failure to follow instructions.

THIS WARRANTY IS IN LIEU OF ALL OTHER WARRANTIES EXPRESSED OR IMPLIED, AND OF ALL OTHER OBLIGATIONS OR LIABILITIES ON OUR PART, INCLUDING THE IMPLIED WARRANTY OF MERCHANTABILITY. THERE ARE NO WARRANTIES WHICH EXTEND BEYOND THE DESCRIPTION ON THE FACE HEREOF. We neither assume, nor authorize any other person to assume for us, any other obligation or liability in connection with the sale of said GOLD MEDAL equipment or any part thereof.

The term "Original Purchaser" as used in this warranty shall be deemed to mean that person, firm, association, or corporation who was billed by the GOLD MEDAL PRODUCTS COMPANY, or their authorized distributor for the equipment.

THIS WARRANTY HAS NO EFFECT AND IS VOID UNLESS THE ORIGINAL PURCHASER FIRST CALLS GOLD MEDAL PRODUCTS COMPANY AT 1-800-428-2676 TO DISCUSS WITH OUR SERVICE REPRESENTATIVE THE EQUIPMENT PROBLEM, AND, IF NECESSARY, FOR INSTRUCTIONS CONCERNING THE REPAIR OR REPLACEMENT OF PARTS.

NOTE: This equipment is manufactured and sold for commercial use only.



GOLD MEDAL PRODUCTS COMPANY
10700 Medallion Drive
Cincinnati, Ohio 45241-4807 USA